



**CLEVER
FRAME**®

**CLEVER
FRAME**®

**CLEVER
FRAME[®]
MODULAR
SALES
SUPPORT
ARCHITECT-
TURE**

CLEVER FRAME® WORLDWIDE

HUNDREDS OF EMPLOYEES WORKING FOR THE SUCCESS
OF THOUSANDS OF CUSTOMERS

HUNDERTE MITARBEITER FÜR TAUSENDE VON KUNDEN

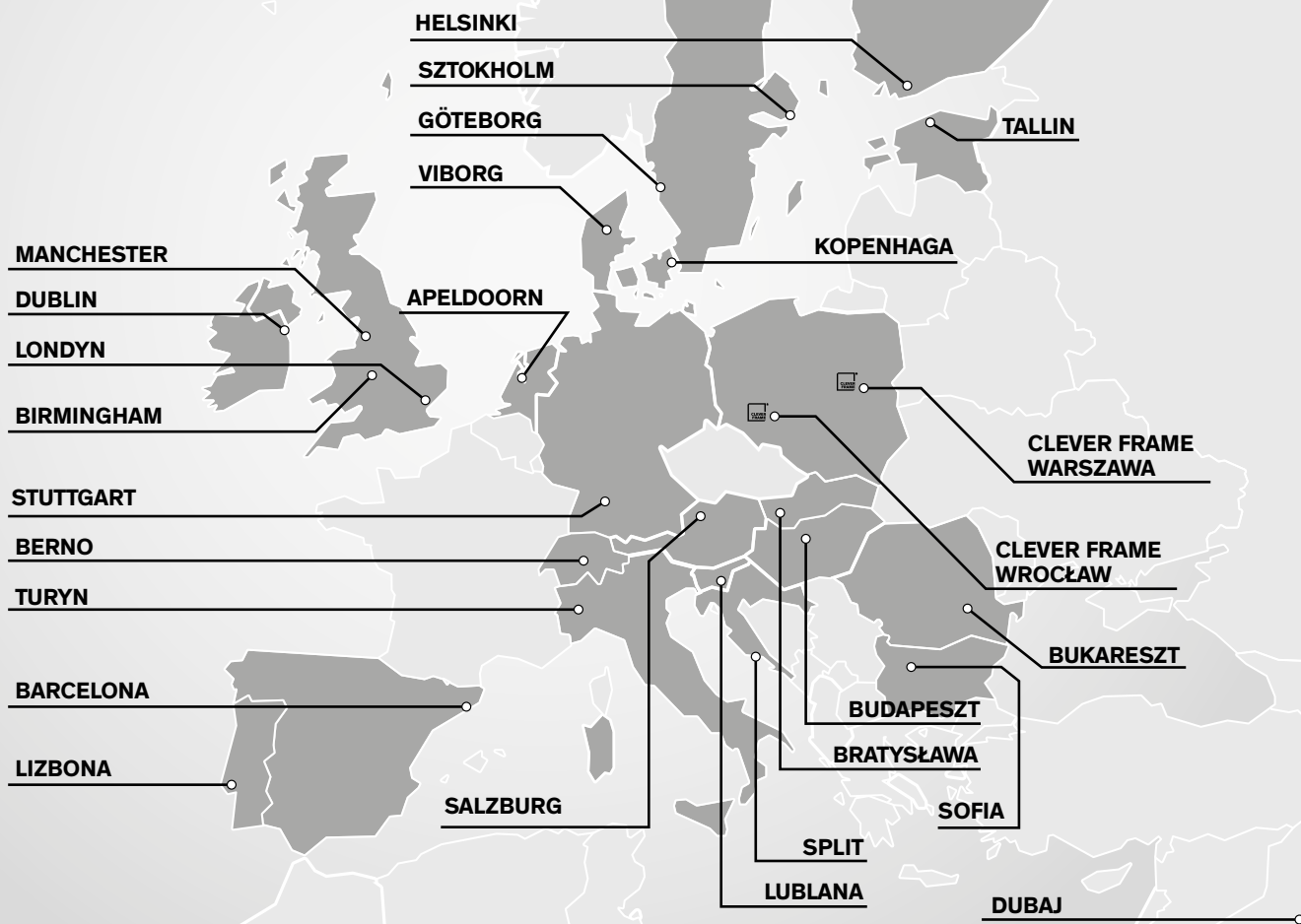

CLEVER FRAME® PHILOSOPHY / CLEVER FRAME®-PHILOSOPHIE

MODULAR SALES SUPPORT ARCHITECTURE



MODULAR

The key to success is efficiency. Our core idea is to create easy to assemble and transport modular systems. Our products are compatible, easy to reconfigure and redesign.

Effektiv zum Erfolg – mit unseren modularen Lösungen, die einfach aufzubauen und zu transportieren sind. Alle Produkte sind miteinander kompatibel und immer wieder neu gestaltbar.



SALES SUPPORT

Product presentation decides about clients' interest in a given brand. Our mission is to create sales points that encourage clients to come back.

Wir unterstützen Sie dabei, Ihre Produkte so zu präsentieren, dass Ihre Kunden begeistert sind und immer wieder kommen.



ARCHITECTURE

We cross borders between product exposition, exhibition, and architecture. Smart space requires in-depth brand analysis and proper ergonomics. That's exactly what we do at Clever Frame® International.

Hier zerfließen die Grenzen zwischen Produktpräsentation, Messebau und Architektur. Durchdacht, analysiert, auf den Nutzer angepasst.

25
TWENTY-FIVE
YEARS OF
CLEVER
VISION

“

Behind the Clever Frame® brand is the 25 years of experience I have gained on the exhibition market. For our team, exhibition architecture is more than exhibition stands – it is a combination of art and craft. In addition to fulfilling functional and formal aspects, it should be the result of a passion for creation.

Hinter der Marke Clever Frame® steht 25 Jahre Erfahrung, die ich in der Messebranche gesammelt habe. Für unser Team ist Ausstellungsarchitektur mehr als nur Messestände – sie ist eine Kombination aus Kunst und Handwerk. Abgesehen von der Erfüllung rein funktionaler und formaler Aspekte sollte sie das Ergebnis einer Leidenschaft für die Schaffung sein.

Filip Grudziński
CEO



BEING RESPONSIBLE DOES NOT END WITH „HERE AND NOW” / VERANTWORTUNGSBEWUSSTSEIN ENDET NICHT MIT DEM „HIER UND JETZT”

The superior objective of Clever Frame is running of business in an ethical, transparent and sustainable manner. Following our over 25-year presence on the market, we take advantage of the possibility to have positive influence on our environment. We are aware of the fact that the decisions which we make today affect our future.

Das übergeordnete Ziel von Clever Frame ist es, die Geschäfte auf ethische, transparente und nachhaltige Weise zu führen. Mit mehr als 25 Jahren Markterfahrung nutzen wir die Gelegenheit, einen positiven Einfluss auf unser Umfeld zu nehmen. Wir sind uns dessen bewusst, dass die Entscheidungen, die wir heute treffen, unsere Zukunft beeinflussen.

CORPORATE SOCIAL RESPONSIBILITY / SOZIALE VERANTWORTUNG DER WIRTSCHAFT

We see our responsibility mainly as the manner of management. We cooperate with local service providers and suppliers we create workplaces not only on manufacturing lines but also on highly specialised positions. We have always been trying to share our experience and provide our Employees with space for implementation of innovative solutions. We try to achieve this through continuous development of team competences and technological capital. The superior rule of our action is ‘win-win’ approach, on the basis of which we build all relations – with our Employees, Customers and Suppliers.

Wir betrachten unsere Verantwortung in erster Linie als eine Art des Managements. Wir arbeiten mit lokalen Dienstleistern und Lieferanten zusammen und schaffen Arbeitsplätze nicht nur an den Produktionslinien, sondern auch in hoch spezialisierten Positionen. Wir waren schon immer bestrebt, unsere Erfahrungen zu teilen und den Mitarbeitern den Raum zu geben, innovative Lösungen umzusetzen. Wir streben danach, dies zu erreichen, indem wir die Kompetenz und das technische Know-how unseres Teams kontinuierlich weiterentwickeln. Unser Leitprinzip ist der ‚Win-Win“-Ansatz, auf dessen Grundlage wir alle Beziehungen aufbauen. Sowohl gegenüber Mitarbeitern als auch bei Kunden oder Lieferanten.





HOW DOES IT WORK? / WIE FUNKTIONIERT ES?

1.

EASY TRANSPORTATION

Light aluminium frames are easy to transport on Clever Frame® trolleys.

EINFACHER TRANSPORT

Problemloser Transport der leichten Rahmen mit passenden Wagen.

2.

MODULARITY WITHOUT ANY TOOLS

With our patented connectors, reconfigurations have never been easier – assemble the frames without any tools.

MODULAR OHNE WERKZEUG

Durch spezielle Verbindungen kinderleicht und schnell zu montieren.

3.

PANELS IN A FEW SECONDS

Within seconds put the magnetic graphic panels into the frames. You may exchange them individually, whenever you want to.

PANEELMONTAGE IM AUGENBLICK

Die Grafikpaneele werden in Sekundenschnelle angebracht – jederzeit einzeln austauschbar.



**SAVING MONEY /
KOSTENEINSPARUNG**





INCREASED SAFETY AND EFFECTIVENESS

Modular solutions mean safety and comfort. With Clever Frame® you are able to make fast marketing decisions. Every time you use the system, you build up the professional image of your brand.

SICHER UND EFFEKTIV

Modulare Lösungen geben Sicherheit und Komfort. Schnelle Marketingentscheidungen werden möglich, und jeder Einsatz stärkt das Markenimage.

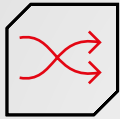

ONE SYSTEM FOR MANY PURPOSES

Clever Frame® equals savings. Today you may need an exhibition stand, tomorrow an event wall. Regardless of your needs, you can create functional constructions.

EIN SYSTEM, VIELE EINSATZMÖGLICHKEITEN

Heute ein Messestand, morgen eine Eventwand – bauen Sie, was Sie möchten, und sparen Sie modular.



NO NEED FOR DISPOSABLE SOLUTIONS

Clever Frame® is a reusable solution. You do not need to buy disposable stands and worry about their quality and esthetics. Focus on savings thanks to the ability to reuse our system.

WIEDERVERWENDBARKEIT

Setzen Sie Clever Frame® immer wieder ein, statt Einmallösungen zu nutzen, und sparen Sie beim Marketingbudget.



EASY IMAGE CHANGES

Rebranding? Seasonal offers? New Strategy? While changing your brand's image you do not need to invest in extra stands. You can change the graphic panels instantly and generate considerable savings.

EINFACHER IMAGEWECHSEL

Rebranding, Saisonabverkauf oder neue Strategie: Die Basis bleibt, nur die Grafikpaneele werden ausgetauscht.



SAVE MONEY EACH TIME YOU USE THE SYSTEM

SPAREN SIE BEI JEDEM EINSATZ

MODULAR MULTIFUNCTIONALITY / MODULARE MULTIFUNKTIONALITÄT

Adjust the shape of your stand, exchange graphic panels, add shelves, TV sets or decorative elements to entirely change your stand.

Mehr als Formveränderung: Verändern Sie Ihren Stand mit neuen Grafikpaneelen, Regalen, TVs oder Dekoelementen.



INFO-POINT



PROMOTIONS PROMOTIONEN



SHOP-IN-SHOP





ONE SYSTEM, MANY FUNCTIONS, HUNDREDS OF RECONFIGURATIONS
 EIN SYSTEM, VIELE FUNKTIONEN, MEHRERE KONFIGURATIONEN

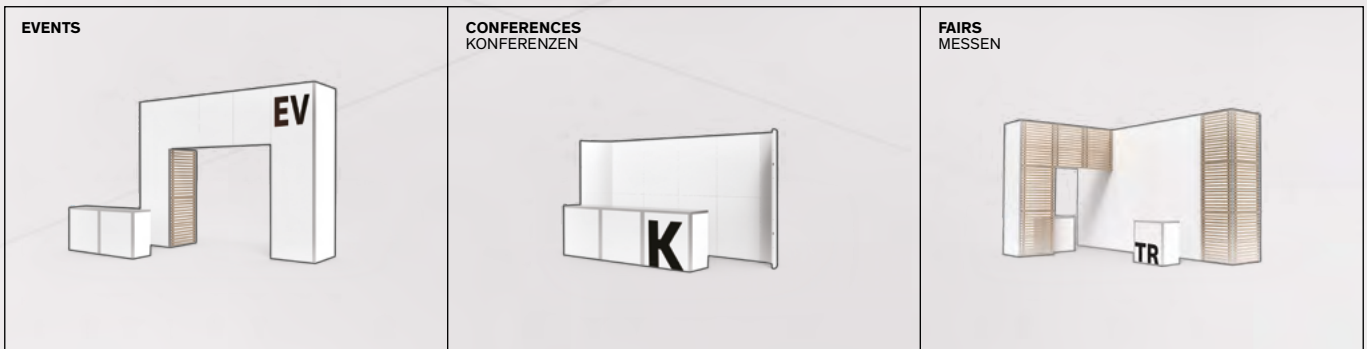

EVEN MORE POSSIBILITIES / IMMER MEHR MÖGLICHKEITEN

See how much time and money you can save when you use one system for many purposes.
The bigger your set is, the more marketing possibilities arise.

Sparen Sie Kosten durch mehrmaligen Einsatz desselben Systems – und ergänzen Sie es, wenn es das Budget zulässt. Mit jedem neuen Set wachsen die Konfigurationsmöglichkeiten.

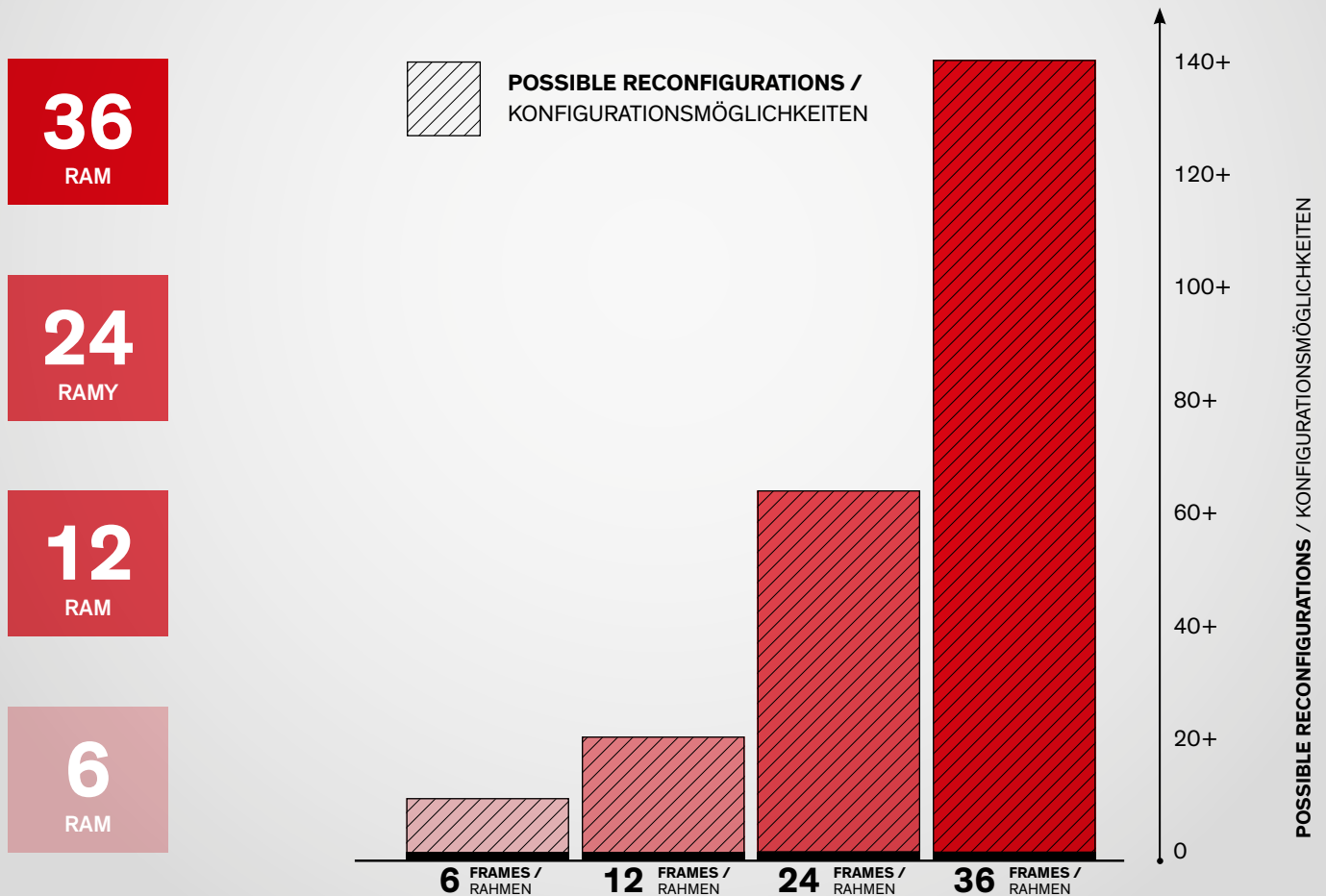

COMFORTABLE TRANSPORT / LEICHTER TRANSPORT



FLIGHT CASE

is capacious and durable, designed to store and transport frames, panels, and accessories.

DAS SYSTEM-CASE

ist robust und garantiert einfachen Transport und sichere Aufbewahrung der Paneele.

TROLLEY FOR FRAMES

allows you to transport up to 6 frames and easily fits in a car.

DER RAHMENWAGEN

fasst 6 Rahmen und passt in einen Pkw. wodurch den Transport erleichtert.

GRAPHIC PANELS CARRY BAG

is durable and guarantees easy transportation and safe panels storage. Easy to carry, fits in a car.

DIE PANEELTASCHE

ist groß und robust – leicht zu transportieren, für sichere Lagerung der Paneele.

**CLEVER
FRAME®
MODULAR
SALES
SUPPORT
ARCHITECTURE**

“

Our products are multifunctional, easy to transport and assemble, designed to create significant savings. This was our main goal.

Unsere Systeme sind multifunktional, mehrfach verwendbar, einfach und schnell ohne Werkzeug aufzubauen und dadurch kostensparend. Und das war unser Ziel.

Szczepan Żabik
Managing Director





6 FRAMES SET / 6-RAHMEN-SET

Promotion space, info point, mobile reception desk or presentation stand.

Für Promotion- oder Infopunkte, mobile Empfangstheken oder Präsentationswände.



EXEMPLARY RECONFIGURATIONS / KONFIGURATIONSBEISPIELE

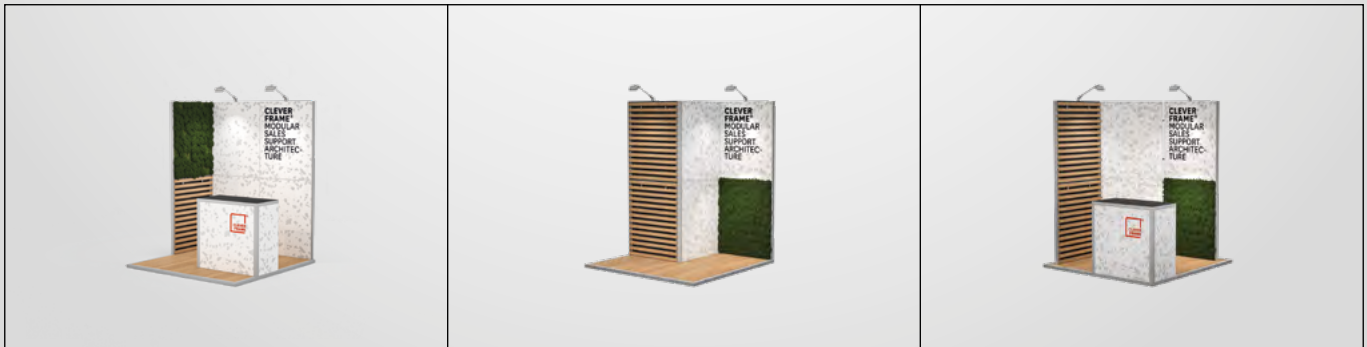

12 FRAMES SET / 12-RAHMEN-SET

For small fair stands or product exposition.

Für kleinere Messestände oder Promotionsflächen.



EXEMPLARY RECONFIGURATIONS / KONFIGURATIONSBEISPIELE

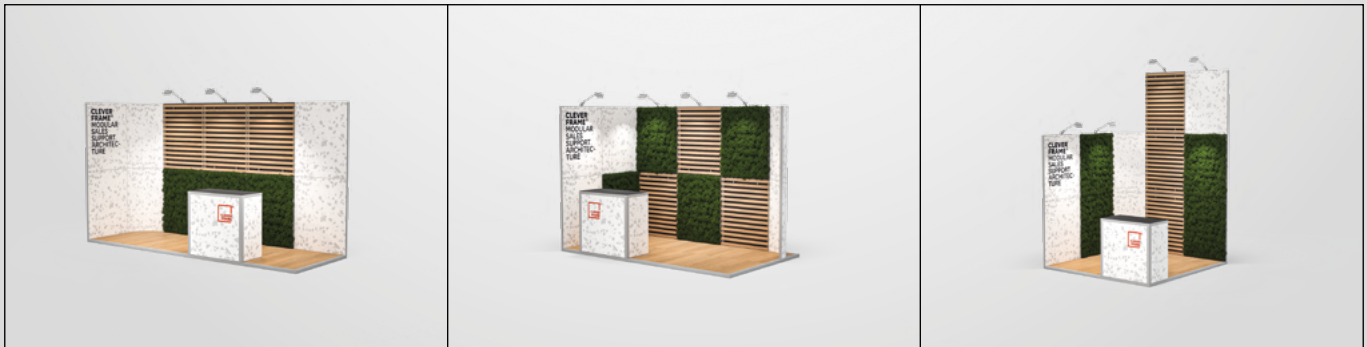

24 FRAMES SET / 24-RAHMEN-SET

Medium set gives you considerable reconfiguration possibilities to increase marketing activities.

Vielfältige Aufbaumöglichkeiten für effizienteres und effektiveres Marketing.



EXEMPLARY RECONFIGURATIONS / KONFIGURATIONSBEISPIELE



36 FRAMES SET / 36-RAHMEN-SET

Bigger, attractive, multifunctional stands and sales points.

Für große, ansprechende und multifunktionale Stände und Verkaufspunkte.



EXEMPLARY RECONFIGURATIONS / KONFIGURATIONSBEISPIELE



**CLEVER
FRAME®
MODULAR
SALES
SUPPORT
ARCHITEC-
TURE**

“

Working directly with the clients, we analyze their needs and expectations. We invest in product development to meet the market and clients' needs.

Die Analyse der Kundenerwartungen ist die Grundlage unseres Handelns. Wir investieren in die Produktentwicklung, um die Bedürfnisse der Kunden und des Marktes zu erfüllen.

Artur Balcerzak
Sales Director





SERW
PERFORM
HOTLINE

Maximalizacja
Mocny
ekspozycja
Szybki
24h pomocy
Wieloletni doświadczenie

PRESENTATION AND FUNCTIONALITY / PRÄSENTATION UND FUNKTIONALITÄT



**1. FLOORING SYSTEM /
SYSTEMBODEN**

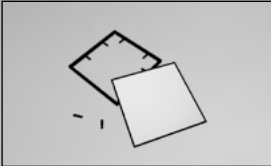

**2. FRAMES /
RAHMEN**

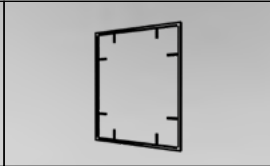

**3. FILLING PANELS /
FÜLLUNGSPANEELE**

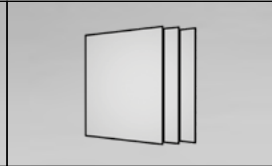

**4. COUNTERS /
TRESSEN**

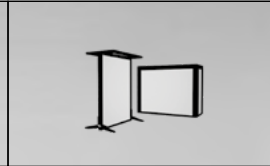

**5. DOOR /
TÜR**

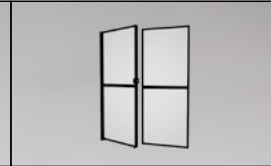

**6. LEAFLET HOLDER /
PROSPEKTHÄLTER**



**7. SHELVES /
REGALE**



**8. LIGHTING /
BELEUCHTUNG**



**9. TRANSPORT SYSTEM /
TRANSPORTSSYSTEM**



**10. PYLONS /
PYLONE**



MULTIMEDIA AND DECORATION / MULTIMEDIA UND DEKORATION



**11. TV /
BILDSCHIRME**

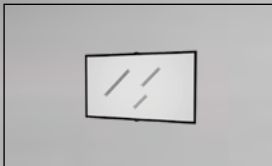

**12. IPAD HOLDER /
TABLET-STÄNDER**

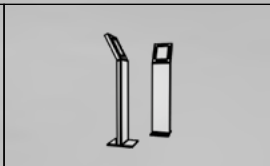

**13. A-FRAME /
ABGESCHRÄGTE RAHMEN**

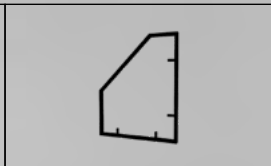

**14. R-FRAME CURVED FRAME /
GEBOGENE RAHMEN**

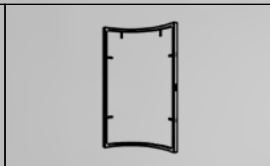

**15. GREEN PANEL /
GRÜN-PANEEL**

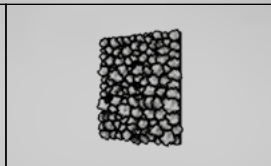

**16. WOODEN PANEL /
HOLZ-PANEELE**

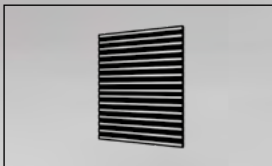

**17. DECO FRAME /
DECO-RAHME**



**18. FURNITURE /
MÖBEL**



**19. DECORATIONS /
DEKORATIONEN**



**20. HELO FORM® DISPLAY SYSTEM /
AUSSTELLUNGSSYSTEM
HELO FORM®**

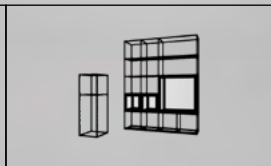

THEY TRUST US / DIESE UNTERNEHMEN VERTRAUEN UNS

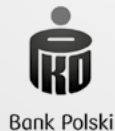



Mercedes-Benz



JAGUAR



FedEx.



MOËT & CHANDON
CHAMPAGNE

GLENMORANGIE
SINGLE MALT SCOTCH WHISKY

K'ARCHER



ORLEN

xerox

PHILIPS

LONGINES®

YES

Johnson & Johnson

NESPRESSO

SANOFI

polpharma

USP Zdrowie

ZEISS

HSBC

Bank Pekao

Raiffeisen
POLBANK

Bank BPS
Grupa BPS

orange™

SEPHORA

Cadbury *W*eddel

Deloitte.

ALL OTHER TRADEMARKS ARE THE PROPERTY OF THEIR RESPECTIVE OWNERS / ALLE RECHTE AN WARENZEICHEN SIND EIGENTUM IHRER JEWEILIGEN INHABER

“

Easy and intuitive system, interesting reconfiguration possibilities.

Leicht und intuitiv zu bedienen mit interessanten Konfigurationsmöglichkeiten.

FONDÉ EN 1742
MOËT & CHANDON
CHAMPAGNE
★

“

Innovative approach to marketing and exhibition.

Marketing und Messebau innovativ gedacht.

 **BOSCH**

“

Easy configuration of Clever Frame® is definitely worth recommending.

Die Konfigurationsleichtigkeit ist unbedingt empfehlenswert.

HITACHI

“

Perfect solution for presenting new and innovative products.

Perfekt für die Präsentation innovativer Produkte.

SIEMENS

“

**Ensures reconfigurations and fast changes
in brand communication.**

Ermöglicht schnellen Umbau und Message-Wechsel.



“

Excellent promotion tool.

Ein perfektes Promotion-Instrument.

OLYMPUS

“

Intuitive, easy, and very effective!

Intuitiv und einfach, dabei so effektiv!



Villeroy & Boch
1748

“

**With Clever Frame® we have increased promotional
activities without additional costs.**

Mehr Promotion-Veranstaltungen ohne zusätzliche Kosten.



Pernod Ricard

CLEVER FRAME® MODULAR SALES SUPPORT ARCHITEC- TURE

“

Clever Frame® is designed to create an effective exposition space, easy to remodel and rebrand, to highlight marketing communication and create professional brand image.

Clever Frame® ist aus dem Wunsch vieler Kunden entstanden, einen Stand zu haben, den man immer wieder neu arrangieren und gestalten kann, um die Marke professionell zu kommunizieren.

Aleksandra Talarczyk
Marketing Manager





CLEVER
FRAME

CLEVER
FRAME

1
A
10

A



AVAKEN

GLASS
ART

GLASS
ART



SIZE /
GRÖßE

◀ 30 m²

▲ 24 m²

One proven way to liven up the trade fair stand arrangement is to introduce intense colours. Vibrant colours draw attention to the key elements of the stand and highlight its modern character.

Zu den bewährten Ansätzen, die einen Messestand beleben, gehören kräftige Farben. Lebhaftige Farben lenken das Augenmerk auf die Schlüsselemente des Standes und unterstreichen seinen modernen Charakter.



**SIZE /
GRÖßE**

▲ 30 m²

▶ 50 m²

Transparencies are a proven way to visually enlarge the stand space. The light that shines through the transparent panels makes the trade fair stand appear brighter and thus more spacious.

Transparenz ist ein bewährtes Mittel, um die Standfläche optisch zu vergrößern. Das durch transparente Paneele einfallende Licht lässt den Messestand heller und damit auch weiträumiger erscheinen.





**SIZE /
GRÖßE**

▲ 6 m²

▶ 28 m²

As many various colours and patterns, so many unique combinations. When designing trade fair stands, we like to go beyond the usual patterns and design exhibition spaces with an individual touch. In search of an interesting effect, we use a variety of materials and textures – the result of these combinations is a bold but coherent and organised whole.

Es gibt so viele verschiedene Farben und Muster, die man kühn kombinieren kann. Bei der Planung von Messeständen gehen wir gerne über die gängigen Schemata hinaus und gestalten Ausstellungsflächen mit einem persönlichen Ansatz. Auf der Suche nach einem ansprechenden Effekt greifen wir zu einer Vielzahl von Materialien und Texturen – das Ergebnis dieser Kombinationen ist ein mutiges, aber stimmiges und strukturiertes Ganzes.





SIZE /
GRÖßE

▲ 66 m²

▶ 24 m²

Functionality and passion for straight lines are among the most important trends in trade fair stand design. The choice of geometric furniture emphasizes the modern style of the exhibition arrangements and gives them a symmetrical dimension.

Funktionalität und die Liebe zur Geradlinigkeit gehören zu den wichtigsten Trends bei der Gestaltung von Messeständen. Der Einsatz geometrischer Möbel betont den modernen Stil der Arrangements der Ausstellung und verleiht ihnen eine symmetrische Dimension.







SIZE / GRÖÖE	◀ 25 m ²	▶ 40 m ²
<p>Stand branding is not only about the proper placement of a logo, but also about being able to use the whole range of finishing materials, furniture and accessories. A clear emphasis on colours and graphics related to the brand's visual identity highlights the character of the brand and perpetuates it in the minds of the audience.</p> <p>Beim Standbranding geht es nicht nur um die passende Platzierung des Logos, sondern auch um die Möglichkeit, eine ganze Reihe von Oberflächenmaterialien, Möbeln und Accessoires zu verwenden. Eine klare Hervorhebung von Farben oder Grafiken, die sich auf die optische Identität der Marke beziehen, betont den Charakter der Marke und prägt sich im Gedächtnis des Publikums ein.</p>		



SIZE / GRÖßE	▲ 20 m²	▶ 30 m²
<p>Our stands are characterized by timeless architecture on a very high level of form and detail. We offer a range of accessories to enhance aesthetic and functional qualities of the stand, such as dedicated lighting or multimedia.</p> <p>Die von uns gestalteten Stände bestehen durch eine zeitlose Architektur mit einer sehr guten Form- und Detailtreue. Wir verfügen über eine Vielzahl an Accessoires, die nicht nur ästhetische, sondern auch funktionale Qualitäten des Standes unterstreichen, wie beispielsweise spezielle Beleuchtung oder Multimedia.</p>		



**TOOLS
INDUSTRY**



#02



**TOOLS
INDUSTRY**



SIZE / GRÖßE	▲ 40 m²	▶ 60 m²
<p>We create based on a specific spatial, aesthetic and functional context. In doing so, we make use of an extensive catalogue of furnishings and finishing materials that allows us to create unique, tailor-made exhibition projects.</p> <p>Wir gestalten auf der Grundlage eines bestimmten räumlichen, ästhetischen und funktionalen Kontexts. Dabei greifen wir auf einen umfangreichen Katalog von Einrichtungs- und Ausstattungsmaterialien zurück, der es uns ermöglicht, einzigartige, maßgeschneiderte Ausstellungskonzepte zu realisieren.</p>		



NEVER
FRAME



SIZE / GRÖßE	▲ 48 m²	▶ 40 m²
-------------------------	---------------------------	---------------------------

When we design trade fair stands in modern style, we focus especially on unusual shapes, vivid colours, dynamic layout and suitable lighting. It is advisable to combine matt and glossy surfaces, glass, metal and structural fillings – such contrasts effectively make the space more dynamic.

Bei der Planung von Messeständen im modernen Stil setzen wir vor allem auf überraschende solide Formen, markante Farben, eine dynamische Gestaltung und eine entsprechende Beleuchtung. Es ist ratsam, matte und glänzende Oberflächen, Glas, Metall und strukturelle Füllungen einander gegenüberzustellen – solche Kontraste beleben den Raum wirkungsvoll.



**CLEVER
FRAME®
MODULAR
SALES
SUPPORT
ARCHITECTURE**

“

Innovation does not equal technology, true innovation is inspired by changes in customer behavior, to create thought-through solutions – like the Clever Frame® system.

Innovation hat nicht nur mit Technologien zu tun, sondern auch mit Verhaltensänderungen durch neue Lösungen – wie bei Clever Frame®.

Maciej Czarnecki
Chief Designer

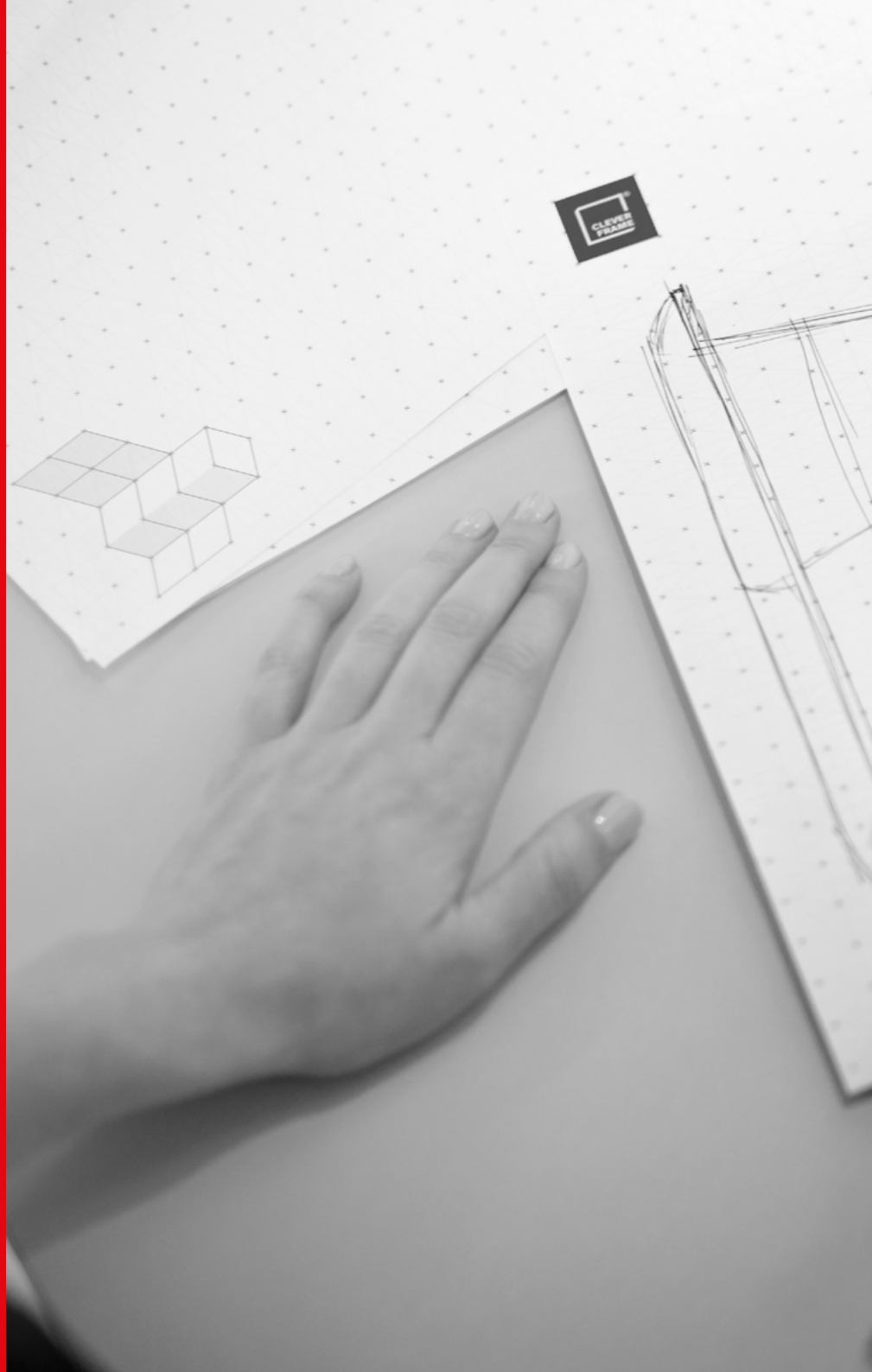

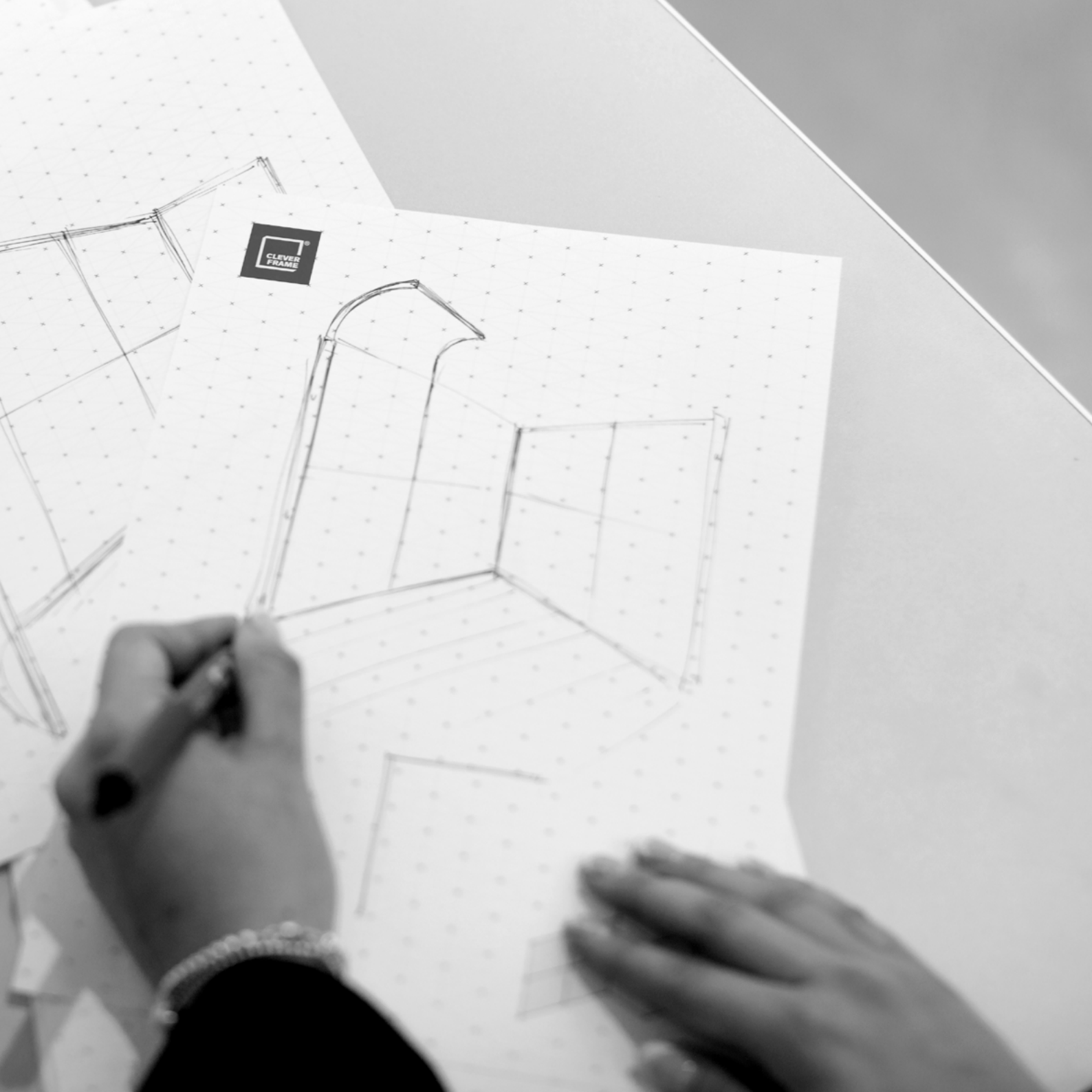

PROMO1

25 STANDS FOR THE PRICE OF 1 / 25 STÄNDE ZUM PREIS VON 1

Set of 6 frames and accessories. Modular, multifunctional system with 25 ready-to-build configurations. Clever Frame® philosophy captured in a Promo1 box.

6 Rahmen, Ablage und weiteres Zubehör: Aus der Basis des Clever Frame® – Systems lassen sich 25 unterschiedliche Stände bauen.



EXEMPLARY RECONFIGURATIONS / BEISPIELKONFIGURATIONEN

1.



2.

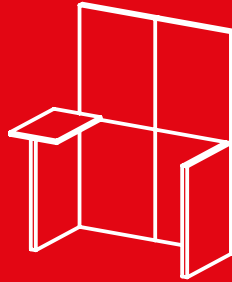

3.

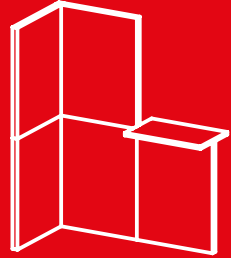

4.

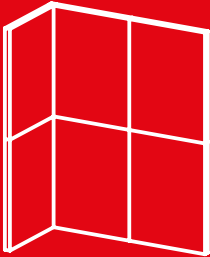

5.



6.



7.



8.



9.

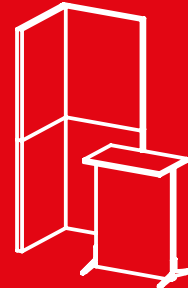

PYLONS
PYLONEN

CLASSIC PRESENTATION / KLASSISCHE PRÄSENTATION

Classic freestanding constructions, multifunctional and durable. Universal marketing tools with exchangeable graphic panels.

Die klassische, freistehende Konstruktion mit vielfältigen Ausbaumöglichkeiten. Stabil und robust, lässt sie sich mit immer neuen Grafikpaneelen für jeden Marketingeinsatz entsprechend gestalten.



DESIGN AND FUNCTIONALITY / ANSPRECHEND UND FUNKTIONAL

Add accessories to adjust pylons to your needs – e.g. use backlit panels for impressive product presentation.

Mit Zubehör werden Pylonen an Ihre Bedürfnisse angepasst – z.B. mit hinterleuchteten Paneelen für eindrucksvolle Produktpräsentation.

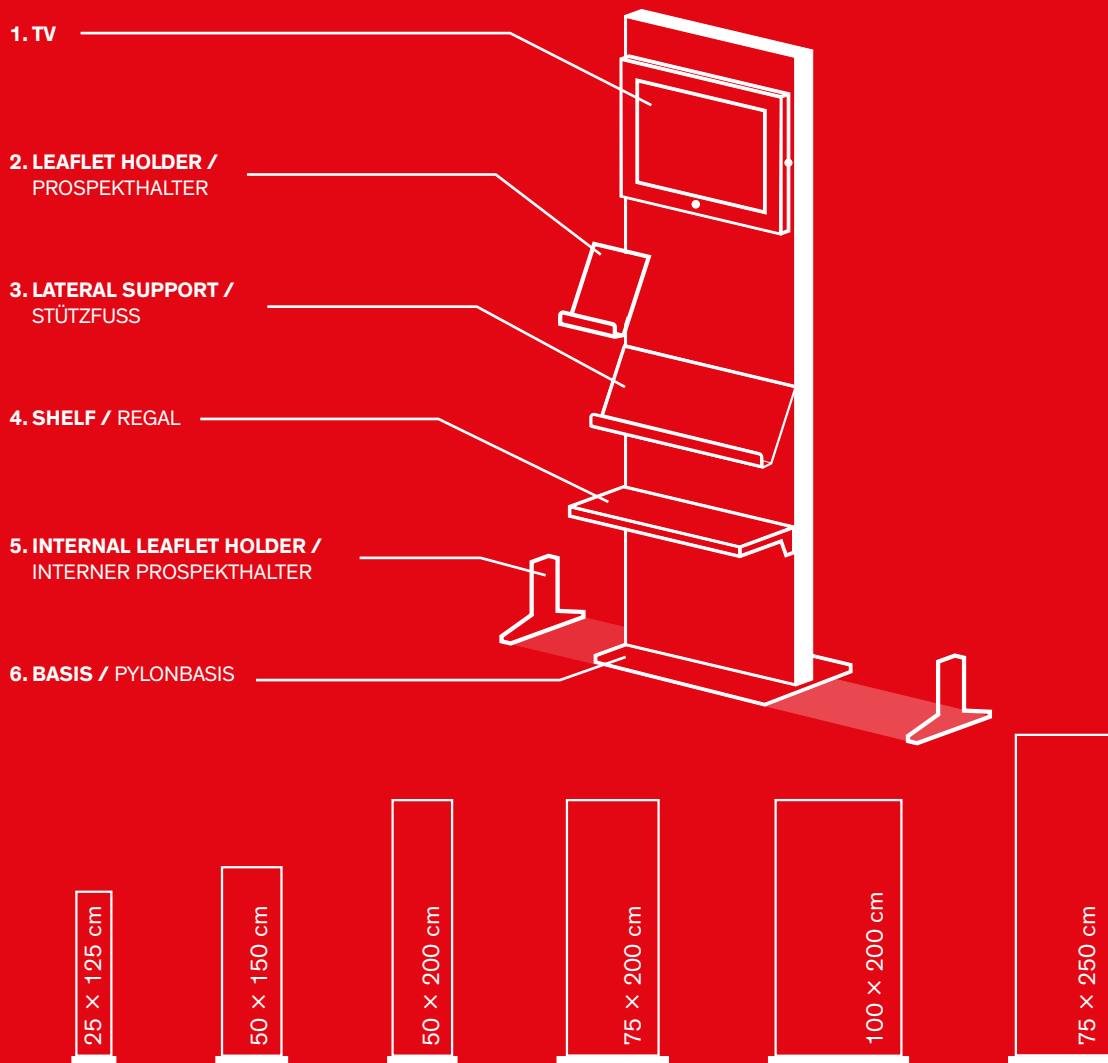

SHOWCASES
VITRINEN

MOBILE SHOWCASES / MOBILE VITRINEN

Showcases are perfect for elegant product presentation. The cabinets will match your brand image thanks to replacable graphic panels.

Vitrinensockel erlauben eine elegante, außergewöhnliche Produktpräsentation – durch Grafikpaneele natürlich optisch auf die Marke abgestimmt.



ACCESSORIES / ZUBEHÖR

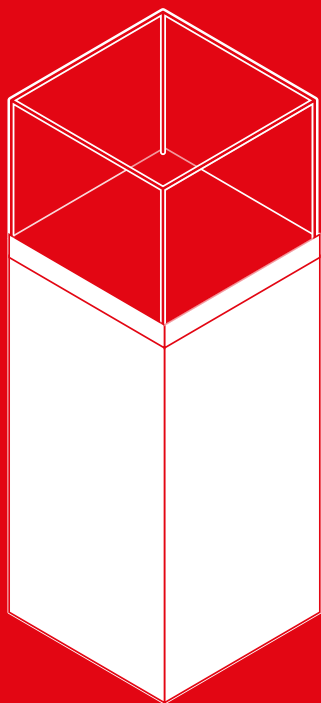

REMOVABLE GLASS /
ABNEHMBARES GLAS

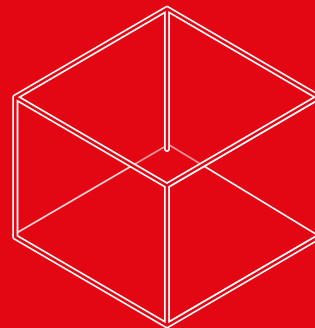

CABINET DOOR /
VITRINE MIT TÜR

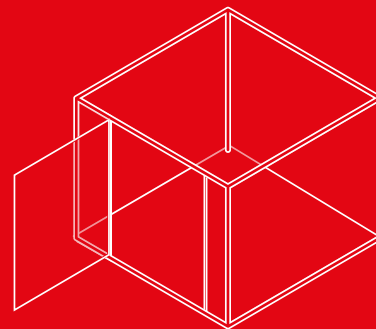

CABINET LIGHTING SYSTEM /
VITRINENBELEUCHTUNG

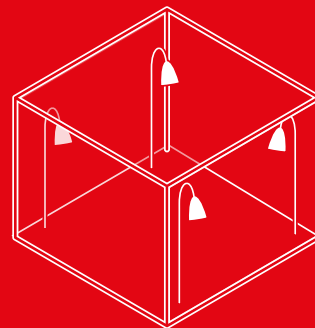



HOME BAKERY
made with love

Types of bread



HOME BAKERY



HOME BAKERY



HOME BAKERY



HOME BAKERY
made with love



HOME BAKERY
made with love



HOME BAKERY
made with love



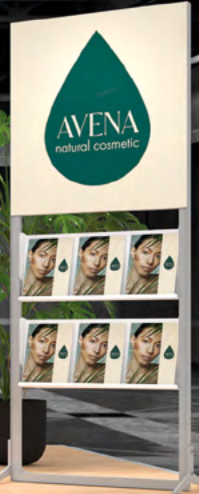
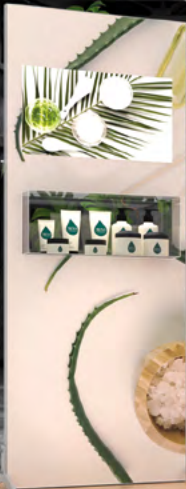

BARS CF

BARS AND COUNTERS / BARS UND THEKEN

Modular, mobile and easy to assemble: bars and counters are ideal for many events and other promotional activities.

Modular, mobil und schnell montiert: Die Bars und Theken passen ideal in die schnelle Event- und Promotionwelt.



SIZES AND ACCESSORIES / GRÖSSEN UND ZUBEHÖR

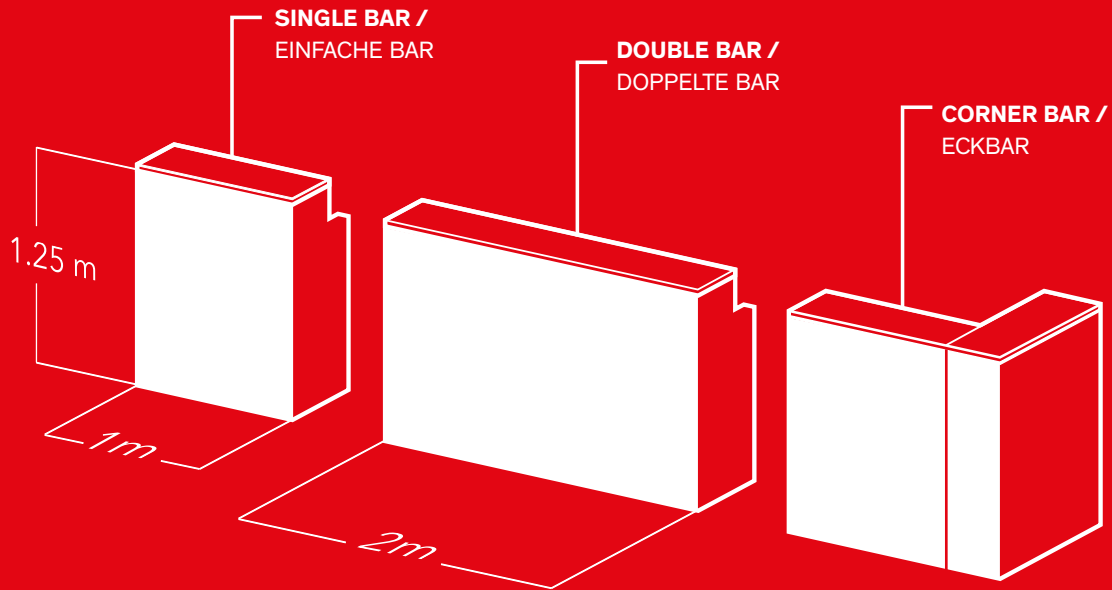

ILLUMINATED PANEL /
BELEUCHTETES PANEEL

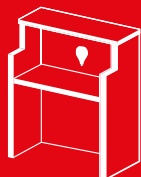

ILLUMINATED COUNTER /
BELEUCHTETE ABLAGE



TOP – 75CM HEIGHT,
ADDITIONAL SHELVES /
ARBEITSPLATTE 75CM HÖHE,
ZUSÄTZLICHE REGALE



ACCESSORIES /
ZUBEHÖR



TRANSPORT

BARS

Adjust Clever Frame® bars and counters to your needs, arrange and rearrange single, double and corner bars.

Clever Frame® Bars können als Eck- oder Reihenbars aufgestellt werden, je nach Platz- und Eventgröße.



CREATING A TIMELESS LOOK, COUPLED WITH A FLAWLESS MOMENT

LOREM IPSUM IS SIMPLY DUMMY TEXT OF THE PRINTING AND TYPESetting INDUSTRY. LOREM IPSUM HAS BEEN THE INDUSTRY'S STANDARD DUMMY TEXT EVER SINCE THE 1500S, WHEN AN UNKNOWN PRINTER TOOK A GALLERY OF TYPE AND SCRAMBLED IT TO MAKE A TYPE SPECIMEN BOOK. LOREM IPSUM IS SIMPLY DUMMY TEXT OF THE PRINTING AND TYPESetting INDUSTRY. LOREM IPSUM HAS BEEN THE INDUSTRY'S STANDARD DUMMY TEXT EVER SINCE THE 1500S, WHEN AN UNKNOWN PRINTER TOOK A GALLERY OF TYPE AND SCRAMBLED IT TO MAKE A TYPE SPECIMEN BOOK.



ACAMA STUDIO



ACAMA STUDIO



HELO FORM®

MODULAR DISPLAY SYSTEMS AND CUSTOMIZABLE RETAIL FURNITURE / MODULARE AUSSTELLUNGSSYSTEME UND GESCHÄFTSMÖBEL

HELO FORM® is an infinitely flexible display and promotional system that can grow with your concepts and marketing needs.

HELO FORM® ist ein unendlich flexibles Display- und Werbesystem, das mit Ihren Konzepten und Marketinganforderungen mitwächst.



THE FORM FOLLOWS YOU / DIE FORM FOLGT IHNEN

1. MINIMALIST DESIGN /
PURISTISCHES DESIGN

2. CUSTOMISABLE / INDIVIDUELL

3. MODULAR AND EVOLVING /
MODULAR & ERWEITERBAR

4. PREMIUM QUALITY /
ERSTKLASSIGE QUALITÄT

5. UNIVERSAL USE /
UNIVERSELL EINSETZBAR

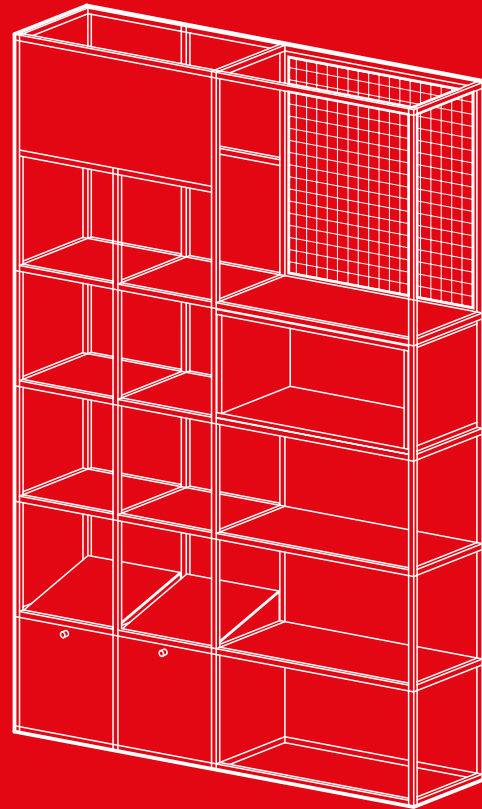

LED LIGHTING /
LED-BELEUCHTUNG



ADVERTISING DISPLAYS /
WERBESCREENS



DRAWERS AND CABINETS /
SCHUBLADEN UND SCHRÄNKE



SHELVES / FACHBÖDEN



CABINET INSERTS /
EINSÄTZE



ORGANIZERS /
ORGANIZER



FLOWERBEDS /
BLUMENKÄSTEN



HOOKS AND RAILINGS /
HAKEN UND SCHIENEN



INTERCHANGEABLE GRAPHICS /
AUSTAUSCHBARE GRAFIKEN

HELO FORM®

DISPLAY RACKS / AUSSTELLUNGSREGALE

A wide choice of modules, construction colours, fronts, filler panels and elements facilitating display and storage, allows for the creation of an almost infinite number of individual designs.

Eine große Auswahl an Modulen, Farben, Fronten, Füllpaneelen sowie Ausstellungs- und Stauraumelementen ermöglicht nahezu unbegrenzte individuelle Gestaltungsmöglichkeiten.





ceramica
ROZZANO

C&S

Bohemian
cristallo glass

P. L. Verner

C&S
Kettle

C&S
Mug set

C&S
Vase

C&S
Mug set

HELO FORM®

PEDESTALS AND DISPLAYS / PODESTE UND DISPLAYS

Display stands in our collection can be used as pedestals for displaying a range of products, platforms for mannequins, clothes and sales counters or tables for testing products.

Die Displays unserer Kollektion können als Podeste für die Präsentation verschiedener Produkte, als Podeste für Schaufensterpuppen, Konditorei- und Verkaufstheken oder als Tische für Produkttests verwendet werden.





Audiofonica
Copenhagen

Audiofonica
Copenhagen

HOME THEATER
SYSTEM

HOME THEATER
SYSTEM

BT-S110
Bluetooth speaker

BT-80 Light
Bluetooth speaker

BT-80 Light
Bluetooth speaker

BT-S110
Bluetooth speaker

HELO FORM®

ISLAND DISPLAYS / VERKAUFSINSELN

Sales island of this type make it possible to professionally implement the principles of visual merchandising and to adapt the design to individual needs, sales ideas or available space.

Verkaufsinself dieser Art ermöglichen es, die Prinzipien des Visual Merchandising professionell umzusetzen und die Gestaltung an individuelle Wünsche, Verkaufsideen oder Platzverhältnisse anzupassen.



Antispherical
POP-UP STORE

new
collection
Spring
2023

SNEAKER
POINT



CLEVER FRAME® MODULAR SALES SUPPORT ARCHITECTURE

“

At Clever Frame we implement the CSR strategy, because as an employer and franchisor we feel co-responsible for shaping the global labour market. We pay attention to choosing only reliable and responsible sub-suppliers. Respect, fair treatment, and solicitude are key to work safety and brand transparency.

Nachhaltiges Denken prägt nicht nur unsere Produkte, sondern auch unseren Alltag – den CSR-Ansätzen folgend, legen wir besonderen Wert auf einen fairen und vertrauensvollen Umgang mit unseren Geschäftspartnern und Mitarbeitern, auf Arbeitssicherheit und soziale Aspekte. Bei der Wahl von Zulieferern achten wir darauf, dass sie die gleichen Werte achten wie wir.

Kamil Kozak
Production Manager





FRAMES / RAHMEN

D1 – 100 × 75 cm

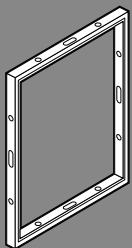

Frames / Rahmen D1

C1 – 100 × 100 cm

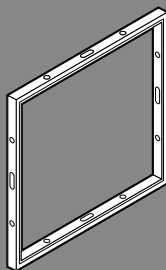

Frames / Rahmen C1

DC1.1 – 100 × 50 cm



Frames / Rahmen DC1.1

DC1.2 – 100 × 25 cm



Frames / Rahmen DC1.2

D2 – 125 × 100 cm

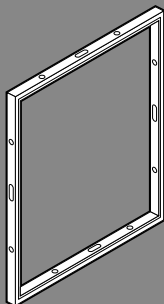

Frames / Rahmen D2

D2.1 – 125 × 75 cm

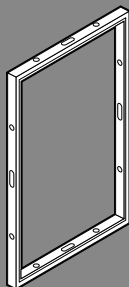

Frames / Rahmen D2.1

D2.2 – 125 × 50 cm

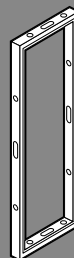

Frames / Rahmen D2.2

D2.3 – 125 × 25 cm



Frames / Rahmen D2.3

RS.D2 – 100 × 125 cm

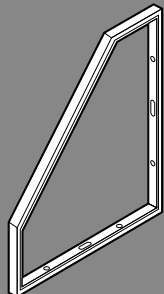

A-Frame D2 / Rahmen A-Frame D2

RT.D1.1 – 75 × 100 cm

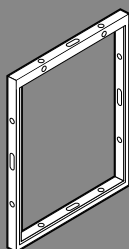

Technical frame D1 /
Technischer Rahmen D1

RT.D1.2 – 100 × 75 cm

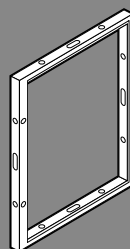

Technical frame D1 /
Technischer Rahmen D1

RT.D2.2 – 125 × 100 cm

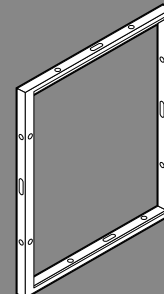

Technical frame D2 /
Technischer Rahmen D2

RT.D2.1 – 100 × 125 cm

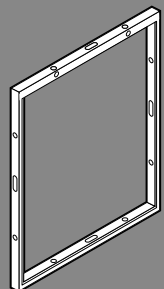

Technical frame D2 /
Technischer Rahmen D2

RT.C1 – 100 × 100 cm

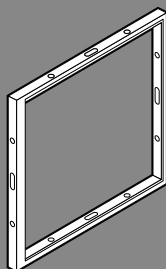

Technical frame C1 /
Technischer Rahmen C1

R1 – 100 cm

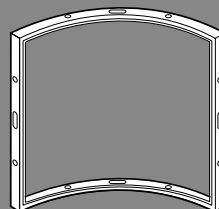

Curved frame R1 /
R1 Bogenrahmen

R2 – 125 cm

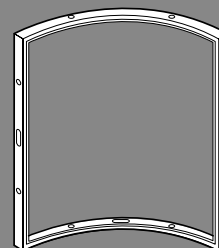

Curved frame R2 /
R2 Bogenrahmen

DOOR / TÜR

ACD200 – 100 × 200 cm

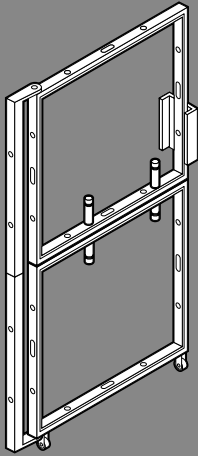

CF Door / CF Tür-System

ACD250 – 100 × 250 cm

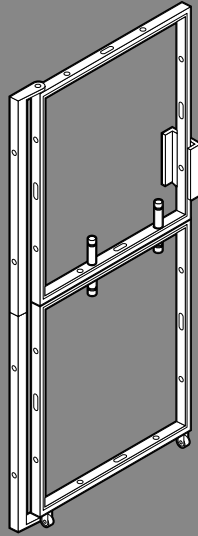

CF Door / CF Tür-System

ACDF200.100 – 100 × 200 cm
ACDF200.105 – 105 × 200 cm
ACDF200.110 – 110 × 200 cm

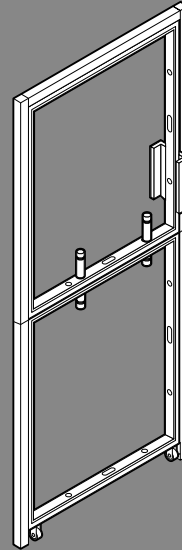

Technical Door /
Technischer Tür-System

PYLON

PL050 – 50 × 200 cm

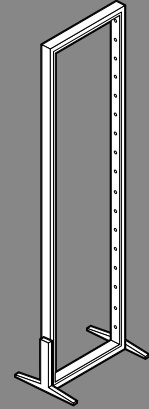

Pylon

PL.075 – 75 × 200 cm

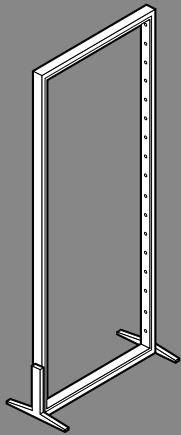

Pylon

PL.100 – 100 × 200 cm

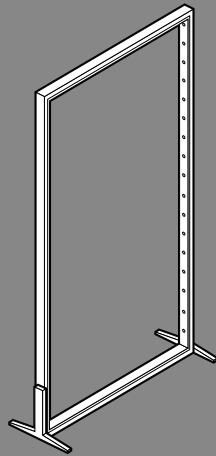

Pylon

PL.075.D – 75 × 200 cm

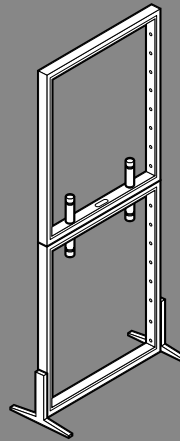

Pylon frame (2 elements) /
Rahmen für zweiteiligen Pylon

PL.100.D – 100 × 200 cm

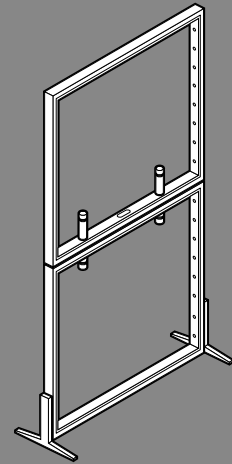

Pylon frame (2 elements) /
Rahmen für zweiteiligen Pylon

COUNTER / THEKE

CT135 – 135 x 100 x 55 cm

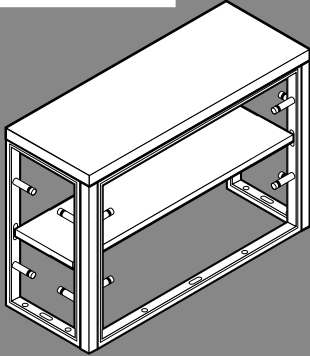

Clever Frame counter /
Clever Frame Theke

CT110 – 110 x 100 x 55 cm

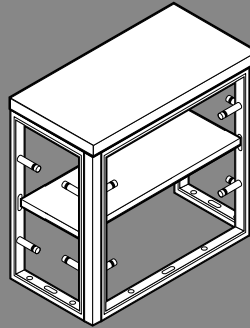

Clever Frame counter /
Clever Frame Theke

CT85 – 85 x 100 x 55 cm

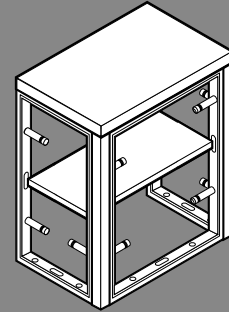

Clever Frame counter /
Clever Frame Theke

CT135.SEC – 135 x 100 x 60 cm

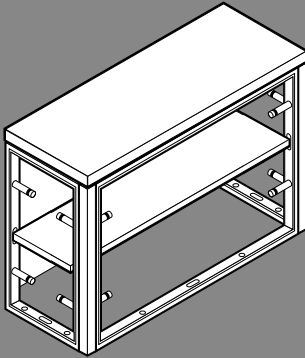

Clever Frame counter, door and lock /
Clever Frame Theke, abschließbar und Tür

CT110.SEC – 110 x 100 x 60 cm

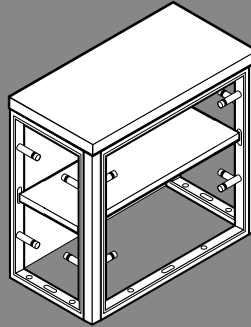

Clever Frame counter, door and lock /
Clever Frame Theke, abschließbar und Tür

CT85.SEC – 85 x 100 x 60 cm

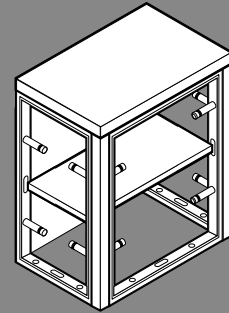

Clever Frame counter, door and lock /
Clever Frame Theke, abschließbar und Tür

ACS05 – 135 cm

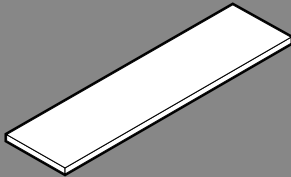

Shelf for the counter / Ablage für Theke

ACS05.1 – 110 cm

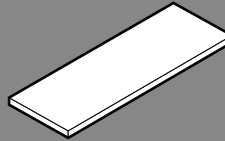

Shelf for the counter / Ablage für Theke

ACS05.2 – 85 cm

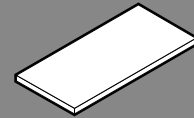

Shelf for the counter / Ablage für Theke

ACS06 – 135 cm

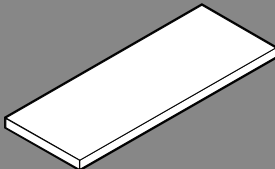

Countertop / Abdeckplatte für Theke

ACS06.1 – 110 cm

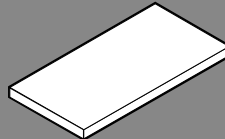

Countertop / Abdeckplatte für Theke

ACS06.2 – 85 cm

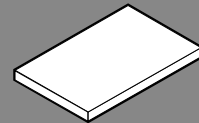

Countertop / Abdeckplatte für Theke

COUNTER / THEKE

TC 125 – 125 × 100 × 55 cm

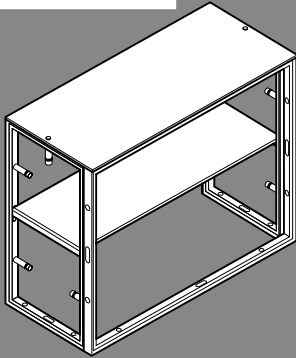

Clever Frame technical counter /
Clever Frame technischer Theke

TC 125.SEC – 125 × 100 × 60 cm

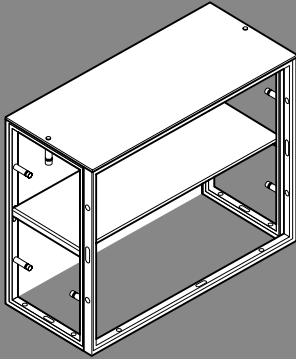

Clever Frame technical counter /
Clever Frame technischer Theke

125 cm

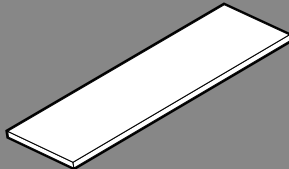

Shelf for the technical counter /
Ablage für technischer Theke

125 cm

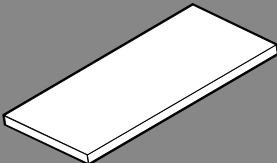

Countertop / Abdeckplatte für technischer Theke

TC 100 – 100 × 100 × 55 cm

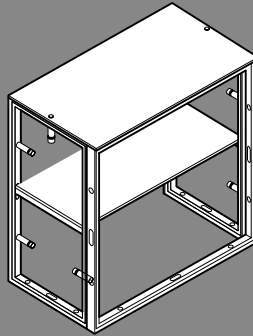

Clever Frame technical counter /
Clever Frame technischer Theke

TC 100.SEC – 100 × 100 × 60 cm

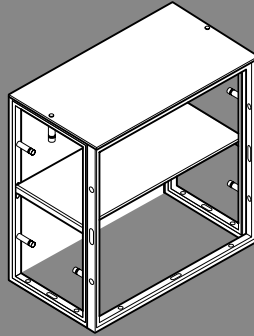

Clever Frame technical counter /
Clever Frame technischer Theke

100 cm

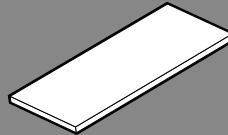

Shelf for the technical counter /
Ablage für technischer Theke

100 cm

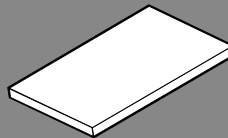

Countertop / Abdeckplatte für technischer Theke

TC 75 – 75 × 100 × 55 cm

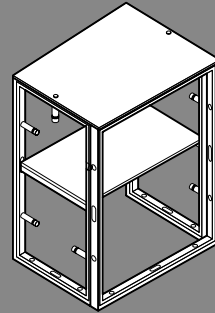

Clever Frame technical counter /
Clever Frame technischer Theke

TC 75.SEC – 75 × 100 × 60 cm

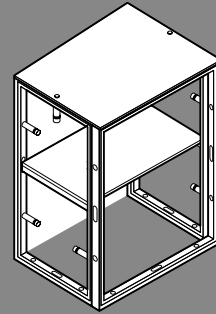

Clever Frame technical counter /
Clever Frame technischer Theke

75 cm

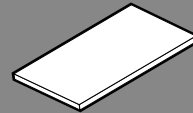

Shelf for the technical counter /
Ablage für technischer Theke

75 cm

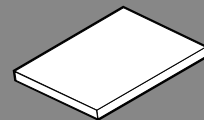

Countertop / Abdeckplatte für technischer Theke

CONNECTORS / VERBINDERS

CON01

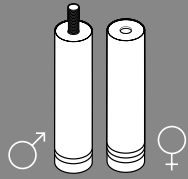

Connectors / Verbinders

male / männlich – CON01.M

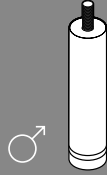

Connectors / Verbinders

female / weiblich – CON01.F

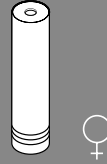

Connectors / Verbinders

FLOOR / FUSSBODEN

FL01 – 100 x 100 cm

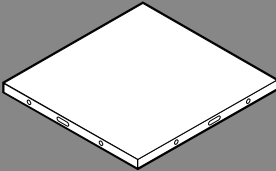

Clever Frame floor system /
Fußboden Clever Frame

COUNTER / THEKE

CTB 100 – 100 x 125 cm

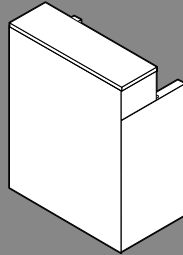

Bar counter / Bartheke

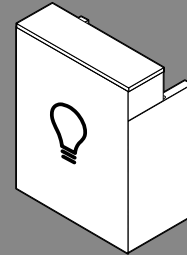

Illuminated bar counter /
Beleuchtete Bartheke

PL,IP

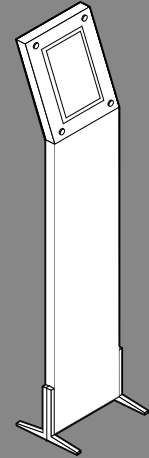

iPad pylon / iPad Pylon

ACS06.4 – 235 cm

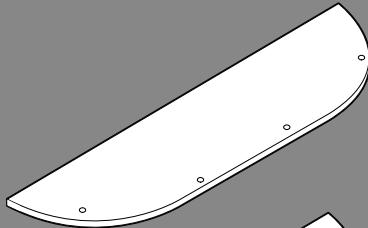

Semicircular countertop /
Abdeckplatte für Halbrundetheke

ACS06.3 – 185 cm

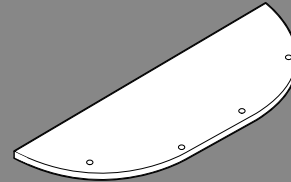

Semicircular countertop /
Abdeckplatte für Halbrundetheke

CTR185 – 185 cm
CTR235 – 235 cm

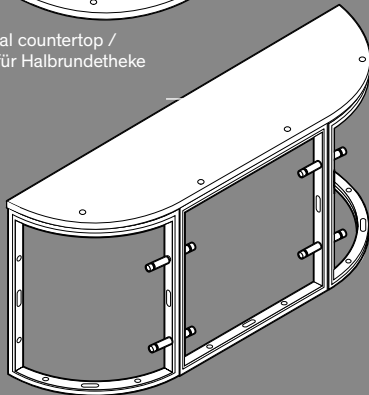

Semicircular Counter /
Halbrunde Theke

CT50

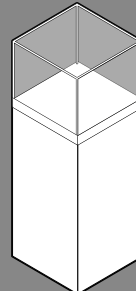

Mobile showcase / Mobile Vitrine

CT50.SEC

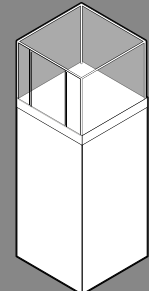

Mobile showcase – lockable /
Mobile Vitrine – abschließbar

PANEL / PANEEL

100 x 75 cm

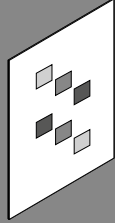

Panel / Paneel D1

PCV: **PD1**
 PLEXI: **PPD1**
 HIPS: **PHD1**

50 x 200 cm

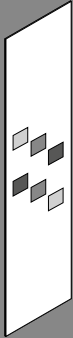

Graphic Panel for Pylon /
 Grafik-Paneel für Pylon

PCV: **PL.G050**
 PLEXI: **PL.PG050**
 HIPS: **PL.HG050**

125 x 75 cm

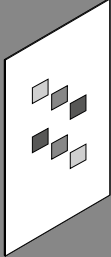

Panel / Paneel D2.1

PCV: **PD2.1**
 PLEXI: **PPD2.1**
 HIPS: **PHD2.1**

R1.1 EXTERNAL

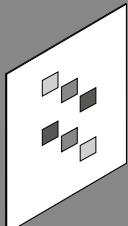

Filler panel R1.1, external /
 Außen-Paneel R1.1 zur Rahmenfüllung

PCV: **PR1.1**

100 x 100 cm

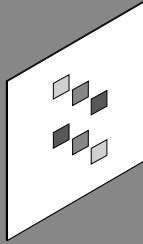

Panel / Paneel C1

PCV: **PC1**
 PLEXI: **PPC1**
 HIPS: **PHC1**

75 x 200 cm

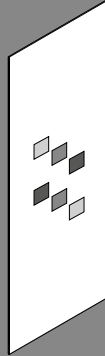

Graphic Panel for Pylon /
 Grafik-Paneel für Pylon

PCV: **PL.G075**
 PLEXI: **PL.PG075**
 HIPS: **PL.HG075**

125 x 50 cm

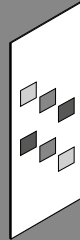

Panel / Paneel D2.2

PCV: **PD2.2**
 PLEXI: **PPD2.2**
 HIPS: **PHD2.2**

R2 INTERNAL

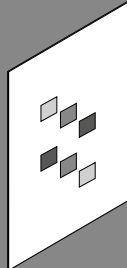

Filler panel R2, internal /
 Innen-Paneel R2 zur Rahmenfüllung

PCV: **PR2**

100 x 50 cm

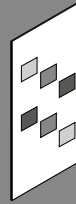

Panel / Paneel DC1.1

PCV: **PDC1.1**
 PLEXI: **PPDC1.1**
 HIPS: **PHDC1.1**

100 x 200 cm

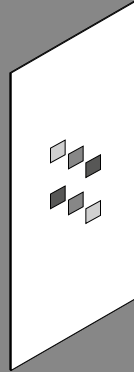

Graphic Panel for Pylon /
 Grafik-Paneel für Pylon

PCV: **PL.G100**
 PLEXI: **PL.PG100**
 HIPS: **HL.HG100**

125 x 25 cm



Panel / Paneel D2.3

PCV: **PD2.3**
 PLEXI: **PPD2.3**
 HIPS: **PHD2.3**

R2.1 EXTERNAL

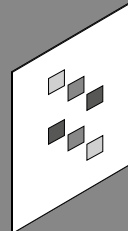

Filler panel R2.1, external /
 Außen-Paneel R2.1 zur Rahmenfüllung

PCV: **PR2.1**

100 x 25 cm



Panel / Paneel DC1.2

PCV: **PDC1.2**
 PLEXI: **PPDC1.2**
 HIPS: **PHDC1.2**

125 x 100 cm

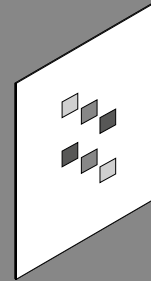

Panel / Paneel D2

PCV: **PD2**
 PLEXI: **PPD2**
 HIPS: **PHD2**

R1 INTERNAL

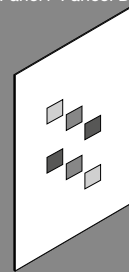

Filler panel R1, internal /
 Innen-Paneel R1 zur Rahmenfüllung

PCV: **PR1**

A-Frame



Panel A-Frame D2 /
 Paneel A-Frame D2

PCV: **PD2AF**

PBC1 – 100 x 100 cm

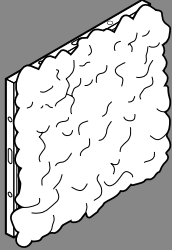

Green panel for C1 frame /
Grünpaneel für C1 Rahmen

PBD2 – 100 x 125 cm

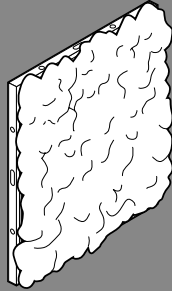

Green panel for D2 frame /
Grünpaneel für D2 Rahmen

PDR.C1 – 100 x 100 cm

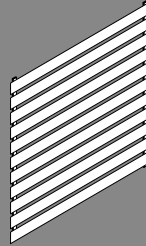

Wooden panel for C1 frame /
Holzpaneel für C1 Rahmen

PDR.D2 – 100 x 125 cm

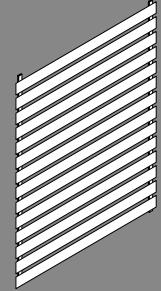

Wooden panel for D2 frame /
Holzpaneel für D2 Rahmen

ACCESSORIES / ZUBEHÖR

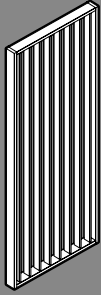

Deco frame / Deco-Rahme

SP075.05 – 75 cm
SP100.05 – 100 cm
SP125.05 – 125 cm



Ending profile / Abschlussprofil

SP075.04 – 75 cm
SP100.04 – 100 cm
SP125.04 – 125 cm

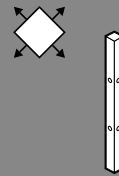

4-side threaded profile /
Profil, vierseitige Vernietung

SP075.03 – 75 cm
SP100.03 – 100 cm
SP125.03 – 125 cm

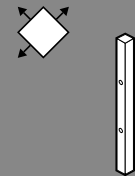

3-side threaded profile /
Profil, dreiseitige Vernietung

SP075.02 – 75 cm
SP100.02 – 100 cm
SP125.02 – 125 cm

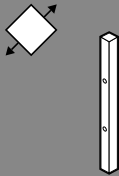

2-side threaded profile /
Profil, zweiseitige Vernietung

SP075.01 – 75 cm
SP100.01 – 100 cm
SP125.01 – 125 cm

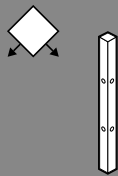

Corner profile / Eckprofil

LS.075.01 – 75 cm
LS100.01 – 100 cm
LS125.01 – 125 cm



Upper profile /
Oberes Abschlussprofil

LS.075.00 – 75 cm
LS100.00 – 100 cm
LS125.00 – 125 cm

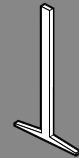

Lower support with leg /
Unteres Abschlussprofil mit Standfuß

PL.S01



Pylon lateral support /
Standfuß für Pylonen

P1.PD



Lateral support for Promo1 /
Stützfüße für Promo1

LSR.50



Lateral support profile for R-Frame /
Abschlussprofil für Bogenrahmen

HIN01

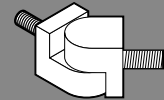

Hinge / Scharnier

ACL02 – 50 W

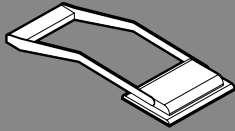

LED Lamp /
LED-Lampe

ACS02.2 – 75 cm

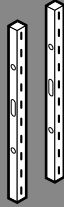

Support profile (set – 2 pcs.) /
Stützprofil (Set je 2 Stück)

ACS02.0 – 100 cm



Support profile (set – 2 pcs.) /
Stützprofil (Set je 2 Stück)

ACS02.1 – 125 cm

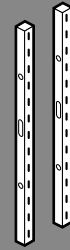

Shelf profile (set – 2 pcs.) /
Stützprofil für Ablage (Set je 2 Stück)

ACL05 – 20 W



LED Lamp /
LED-Lampe

ACS03.75 – 75 x 28 cm

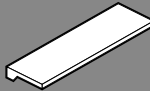

Shelf / Regal

ACS03.100 – 100 x 29 cm

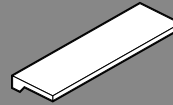

Shelf / Regal

HOL.75

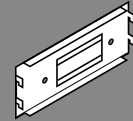

TV holder for 75 cm frame /
TV-Halterung 75 cm Rahmen

HOL.100

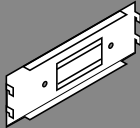

TV holder for 100 cm frame /
TV-Halterung 100 cm Rahmen

LH01.R – right / rechts

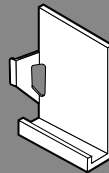

Leaflet holder A4 /
Prospekthalter A4

LH01.L – left / links

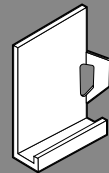

Leaflet holder A4 /
Prospekthalter A4

ACS08

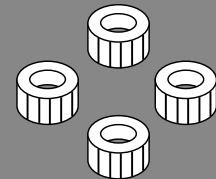

Mounting rings (4 pcs.) /
Befestigungsring (4 Stück)

LHT01.75 – 75 cm
LHT01 – 100 cm

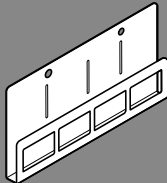

Straight leaflet holder for the technical
frame / Gerader Prospekthalter für den
technischen Rahmen:

LHT02.75 – 75 cm
LHT02 – 100 cm

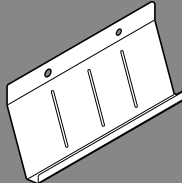

Slanting leaflet holder for the technical
frame / Schräger Prospekthalter für den
technischen Rahmen

LH03.01 – 75 cm
LH03.02 – 100 cm

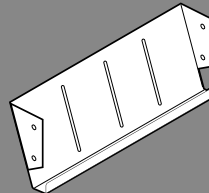

Leaflet holder for the pylon / Interner
Prospekthalter für Pylone

LH02

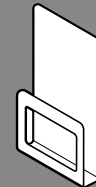

Leaflet holder for lateral support profile /
Prospekthalter für Abdeckleisten

BAG / TASCH

ACT08

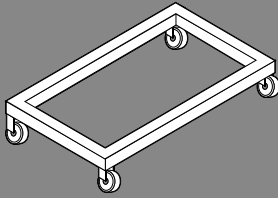

Aluminium Trolley (6 Frames) /
Aluminium-Trolley (6 Rahmen)

ACT10

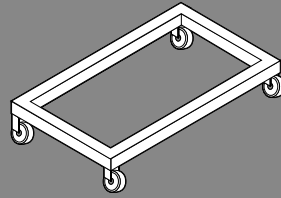

Aluminum Trolley for R-Frame /
Aluminium-Trolley für Bogenrahmen

ACT09

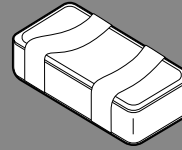

Carry bag for 6 lamps /
Transporttasche für 6 Lampen

ACT07

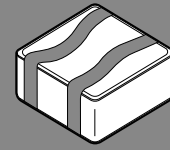

Connector bag /
Tasche für Verbinder

ACT01

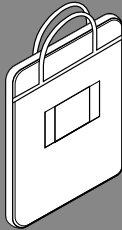

Carry bag for D1 Panels /
Transporttasche für Grafik-Paneele D1

ACT04

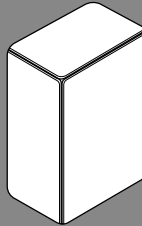

Trolley cover for D1 frames /
Schutzhülle für Aluminium-Trolley D1

FLCS.01

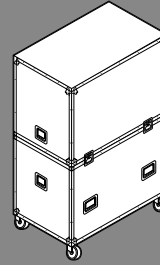

Universal Flight Case

PROMO 1

PRM0

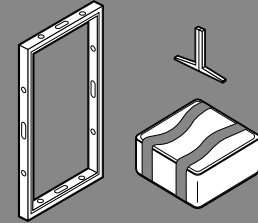

Promo1 Set excl. panels /
Promo1 ohne Paneele

ACT02

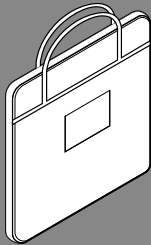

Carry bag for C1 Panels /
Transporttasche für Grafik-Paneele C1

ACT05

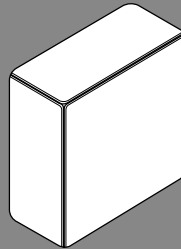

Trolley cover for C1 frames /
Schutzhülle für Aluminium-Trolley C1

PRM1

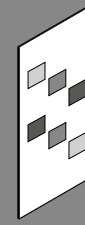
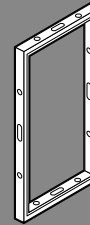

Promo1 Set

ACT03

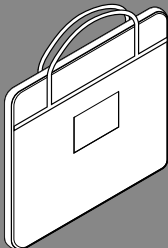

Carry bag for D2 Panels /
Transporttasche für Grafik-Paneele D2

ACT06

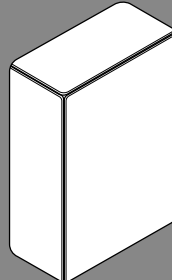

Trolley cover for D2 frames /
Schutzhülle für Aluminium-Trolley D2

PRM1.PG

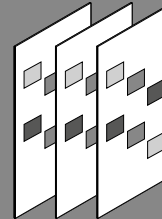

12 Promo1 Panels /
12 Promo 1 Paneelen

P1.BL

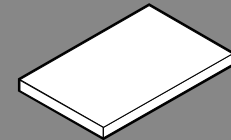

Promo1 Table Top /
Promo 1 Tischplatte





Clever Frame Sp. z o. o.
Grota Roweckiego 203
52-214 Wrocław, Poland

office@cleverframe.com
www.cleverframe.com